

OPERATING MANUAL

AIR CONDITIONER
Wall Mounted Type



ASTG30KMTC

MODEL: **ASTG34KMTC**

* Please check the model name.
(Refer to the rating label.)



Before using this product, read these instructions thoroughly. Also, keep this manual for future reference, together with the installation manuals for the indoor and outdoor units.



PART No. 9387081237-02

FUJITSU GENERAL LIMITED

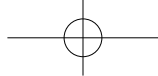

Contents

- 1. SAFETY PRECAUTIONS..... 1
- 2. PREPARATION..... 2
- 3. NAME OF PARTS 3
 - 3.1. Indoor unit 3
 - 3.2. Remote controller 3
- 4. BASIC OPERATIONS 5
- 5. AIRFLOW SETTINGS 5
 - 5.1. Fan speed setting 5
 - 5.2. Airflow direction setting 5
- 6. TIMER OPERATIONS 5
 - 6.1. Weekly timer..... 6
 - 6.2. On timer or Off timer..... 6
 - 6.3. Program timer..... 6
 - 6.4. Sleep timer 6
- 7. ENERGY SAVING OPERATIONS 7
 - 7.1. Economy operation 7
 - 7.2. Human sensor for energy saving 7
 - 7.3. Fan control for energy saving..... 7
 - 7.4. Demand Response 7
- 8. OTHER OPERATIONS 8
 - 8.1. Powerful operation 8
 - 8.2. Outdoor Unit Low Noise operation 8
 - 8.3. 10 °C Heat operation..... 8
- 9. SETTINGS ON INSTALLATION..... 8
 - 9.1. Remote controller adjustment 8
- 10. CLEANING AND CARE..... 9
- 11. GENERAL INFORMATION 11
- 12. OPTIONAL PARTS 11
 - 12.1. Wired remote controller 11
- 13. TROUBLESHOOTING 12

1. SAFETY PRECAUTIONS

To prevent personal injury or property damage, read this section carefully before you use this product, and be sure to comply with the following safety precautions.

In order to prevent operation due to failure to follow the instructions may cause harm or damage, the seriousness of which is classified as follows:

WARNING

This mark warns of death or serious injury.

CAUTION

This mark warns of injury or damage to property.

This mark denotes an action that is PROHIBITED.

This mark denotes an action that is COMPULSORY.

Explanation of symbols displayed on the indoor unit or outdoor unit.

WARNING

This symbol shows that this product uses a flammable refrigerant. If the refrigerant is leaked and exposed to an external ignition source, there is a risk of fire.

CAUTION

This symbol shows that the operating manual should be read carefully.

CAUTION

This symbol shows that a service person should be handling this equipment with reference to the installation manual.

CAUTION

This symbol shows that information is available as in the operating manual or installation manual.

WARNING

- The appliance shall be installed, operated and stored in a room with a floor area larger than X m².

Amount of refrigerant charge M (kg)	Minimum room area X (m ²)
M ≤ 1.22	-
1.22 < M ≤ 1.23	1.45
1.23 < M ≤ 1.50	2.15
1.50 < M ≤ 1.75	2.92
1.75 < M ≤ 2.0	3.82
2.0 < M ≤ 2.5	5.96
2.5 < M ≤ 3.0	8.59
3.0 < M ≤ 3.5	11.68
3.5 < M ≤ 4.0	15.26

(IEC 60335-2-40)

- This product contains no user-replaceable parts. Always consult authorized service personnel for repairing, installation, and relocation of this product. Improper installation or handling will cause leakage, electric shock, or fire.
- In the event of a malfunction such as burning smell, immediately stop operation of the air conditioner, and disconnect all the power supply by turning off the electrical breaker or disconnecting the power plug. Then consult authorized service personnel.
- Take care not to damage the power supply cable. If it is damaged, it should be replaced only by authorized service personnel in order to avoid a hazard.
- In the event of refrigerant leakage, be sure to keep away from fire or any flammables, and consult authorized service personnel.
- In the event of a thunder storm or any prior sign of a lightning strike, turn off the air conditioner via the remote controller, and refrain from touching the product or the power source to prevent any electrical hazards.
- This product shall be stored in a room without continuously operating ignition sources (for example: open flames, an operating gas appliance or an operating electric heater).
- This product shall be stored in a well-ventilated area.
- Be aware that refrigerants may not contain an odour.
- This product shall be stored so as to prevent mechanical damage from overturning.
- Disposition of the product shall be done properly in compliance with national or regional regulations.
- During transportation or relocation of the indoor unit, pipes shall be covered with the wall hook bracket for protection.
Do not move this product by holding the indoor unit pipes. (The stress applied to the pipe joints may cause the flammable gas to leak during operation).

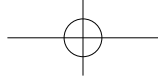

! WARNING

- ! This product is not intended for use by persons (including children) with reduced physical, sensory or mental capabilities, or lack of experience and knowledge, unless they have been given supervision or instruction concerning use of this product by a person responsible for their safety. Children should be supervised to ensure that they do not play with this product.
- ! Do not use the packaging materials safely. Tear and disposal of the plastic packaging bags so that children cannot play with them. There is danger of suffocation if children play with the original plastic bags.
- ! Do not install the unit in area filled with mineral oil or as a factory or area containing a large amount of petroleum oil or steam as a kitchen.
- ! Do not start or stop the operation of this product by inserting or pulling out the power plug, or by turning on or off the circuit breaker.
- ! Do not use flammable gases near this product.
- ! Do not expose yourself directly to the cooling airflow for many hours.
- ! Do not insert your fingers or any other objects into outlet port or inlet port.
- ! Do not operate with wet hands.
- ! Do not use means to accelerate the defrosting process or to clean this product, other than those recommended by the manufacturer.
- ! Do not pierce or burn.

! CAUTION

- ! Provide adequate ventilation during use.
- ! Always operate this product with air filters installed.
- ! Ensure that any electronic equipment is at least 1 m (40 in) away from this product.
- ! Disconnect all the power supply when not using this product for extended periods.
- ! After a long period of use, ensure to get the mounting of the indoor unit checked to prevent this product from falling down.
- ! The airflow direction and the room temperature should be carefully considered when you use this product in a room with infants, children, elderly or sick persons.
- ! Keep the surroundings of the outdoor unit clean and tidy and do not place items around it. Any objects blocking or entering from the outlet ports may cause product malfunction.
- ! Do not direct the airflow at fireplaces or heating apparatus.
- ! Do not block or cover the intake grille and the outlet port.
- ! Do not apply any heavy pressure to radiator fins.
- ! Do not climb on, place objects on, or hang objects from this product.
- ! Do not place any other electrical products or household belongings under this product. Dripping condensation from this product might get them wet, and may cause damage or malfunction of your property.
- ! Do not expose this product directly to water.
- ! Do not use this product for preservation of food, plants, animals, precision equipment, art work, or other objects. This may cause quality deterioration of those items.
- ! Do not expose animals or plants to the direct airflow.
- ! Do not drink the drainage from the air conditioner.
- ! Do not pull the power supply cable.
- ! Do not touch the aluminum fins of heat exchanger built-in this product to avoid personal injury when you maintain the unit.
- ! Do not stand on unstable steps when operating or cleaning this product. It may overturn and can cause injury.

This product contains fluorinated greenhouse gases.

2. PREPARATION

! WARNING

- ! Take care to prevent infants and young children from accidentally swallowing the batteries.

! CAUTION

- ! If leaking battery fluid comes in contact with your skin, eyes or mouth, immediately rinse with plenty of clean water, and consult your physician.
- ! Exhausted batteries must be removed immediately, and be disposed according to the local laws and regulations of your region.
- ! Do not attempt to recharge dry batteries.
- ! Do not use dry batteries that has been recharged.

Indoor unit accessories

Please check that the following accessories are included.

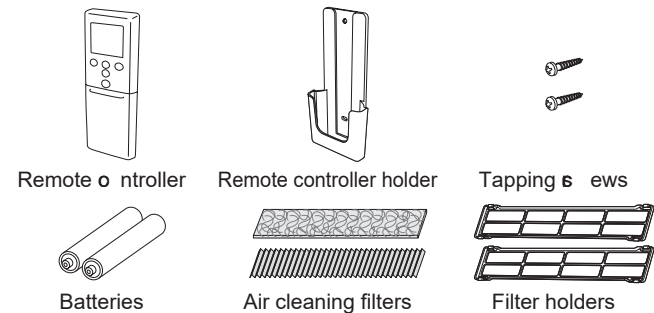

Remote controller holder installation

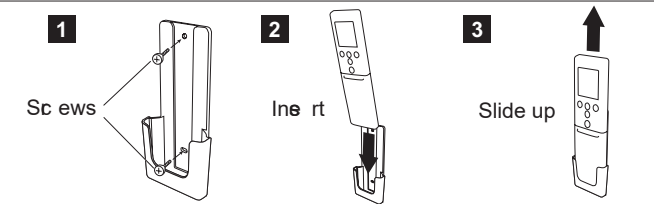

Battery loading and remote controller preparation (R03/LR03/AAA x 2)

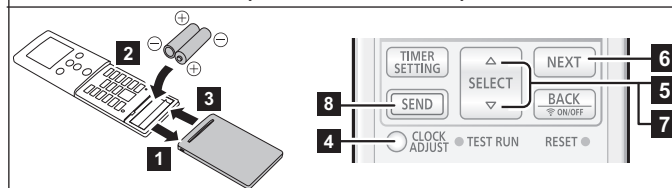

- 1-3. Put batteries as shown in the figure above.
4. Press **CLOCK ADJUST** to start clock setting.
5. Press **SELECT** (Δ / ∇) to set day of the week (Monday to Sunday).
 - * By pressing **TEMP.** (\odot / \ominus), the time indicator can be changed from a 24-hour to a 12-hour clock.
6. Press **NEXT** to continue.
7. Press **SELECT** (Δ / ∇) to set the clock.
 - Press the buttons to change the clock by a minute.
 - Press down the buttons to change the clock by 10 minutes.
8. Press **SEND** to complete the setting.
 - Be close to the indoor unit. If you press the button from a distance, settings may not be properly sent.

NOTES:

- Use specified type of batteries only.
- Do not mix different types or new and used batteries together.
- Batteries can be used about 1 year in ordinary use.
- If the remote control range noticeably shortens, replace the batteries and press **RESET** as shown in page 4.
- When you replace the batteries the settings will be initialized.

3. NAME OF PARTS

CAUTION

For appropriate signal transmission between the remote controller and the indoor unit, keep the signal receiver away from the following items

- Direct sunlight or other strong lights
- Flat-panel television screen

In rooms with instantaneous fluorescent lights, such as inverter type ones, the signal may not be transmitted properly. In such a case, orient the store of purchase.

3.1. Indoor unit

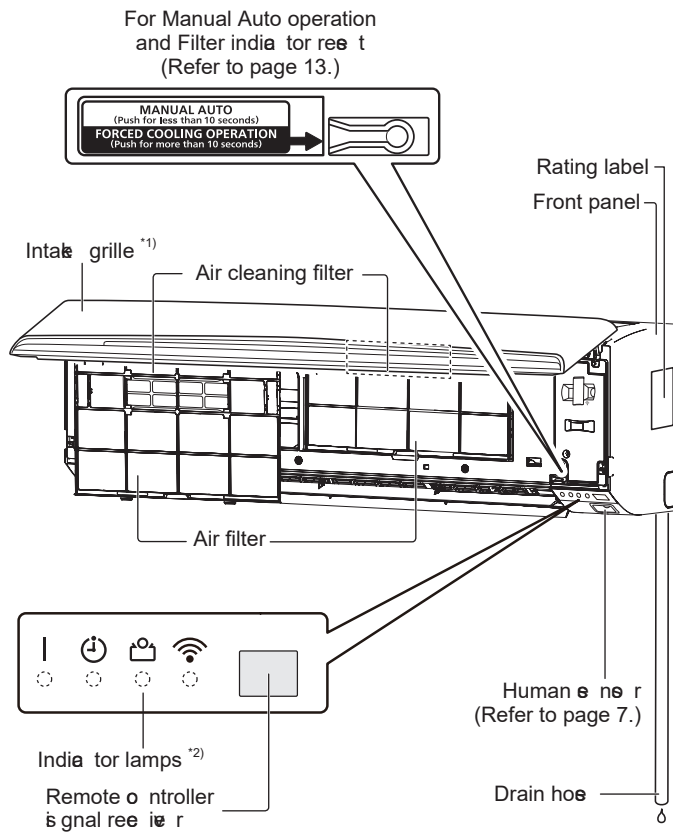

*1) Before starting operation, make sure that the intake grille is closed completely. Incomplete closing may affect the proper function or performance of the product.

*2) Indicator lamps light in the following conditions

	Name	Color	Operation or condition
	Operation	Green	Normal operation
🕒	Timer	Orange	Timer operation
🏠	Economy	Green	Economy operation 10 °C Heat operation
📶	—	Orange	Function not available (This lamp may blink. Refer to page 11 and 12.)

3.2. Remote controller

When you use the optional remote controller, the appearance and the operation procedure may differ.

For details please refer to the operating manual of each remote controller.

- * : The setting must be done while the setting screen is displayed for each function.
- | : The button is controllable only when the air conditioner is operating.

Signal transmitter

Aim at the signal receiver of the indoor unit properly.

- Operating range is approximately 7 m.
- [▲] will appear when the signal is transmitted.
- The indoor unit will emit a beep when it receives the signal properly. If there is no beep, press the button again.

Remote controller display

In this section, all the possible indicators are displayed for description. In actual operation, the display is linked with the button operation, and only shows the necessary indicators for each setting.

For Basic operations Refer to page 5.

🔌	Starts or stops the air conditioner operation.	
MODE	Changes the operation mode.	*
TEMP.	Adjusts the setting temperature.	*
⬆️		
⬇️		

For 10 °C Heat operation Refer to page 8.

🏠 10°C HEAT	Activates the 10 °C Heat operation.	
○		

For Energy saving operations Refer to page 7.

🏠 ECONOMY	Activates or deactivates the Economy operation.	
ENERGY SAVING PROGRAM	Activates or deactivates the Energy saving program that uses the human sensor.	
SENSOR		

For Outdoor Unit Low Noise operation ... Refer to page 8.

OUTDOOR UNIT LOW NOISE	Activates or deactivates the Outdoor Unit Low Noise operation.	
------------------------	--	--

Do not press this button in normal use.

It starts the test run (for use by authorized service personnel only).

NOTES: If the test run starts unintentionally, press (🔌) to quit the test run.

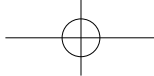

CAUTION

- To prevent malfunction or damage of the remote controller:
 - Place remote controller at where will not be exposed to direct sunlight or excessive heat.
 - Remove batteries if the product is not going to be used for an extended period.
- Obstacles such as a curtain or wall between the remote controller and the indoor unit may affect the appropriate signal transmission.

Do not apply strong blows to the remote controller.
Do not pour water on the remote controller.

For Powerful operation Refer to page 8.

POWERFUL At times or deat times the Powerful operation. |

For Airflow settings Refer to page 5.

FAN Controls the fan speed. *|

SWING Sets the automatic Swing operation. *|

SET Controls the horizontal airflow direction. |

SET Controls the vertical airflow direction. |

For Timer operations Refer to page 5.

WEEKLY At times or deat times the Weekly timer.

ON/OFF Activates or deactivates the On timer, Off timer, or Program timer.

SLEEP At times or deat times the Sleep timer.

TIMER SETTING Starts the timer setting.

SEND Sends the timer or block setting to the indoor unit. (Do not long press) *

NEXT Forwards the timer or block setting to the next step.

BACK ON/OFF Returns the timer or block setting to the previous step. (Do not long press) "ON/OFF" is not available.

SELECT Adjusts the value of the timer or block settings

CLOCK ADJUST Starts the block setting.

After replacing batteries

RESET Press this button as shown in the following figure. Use a tip of a ballpoint pen or other small object.

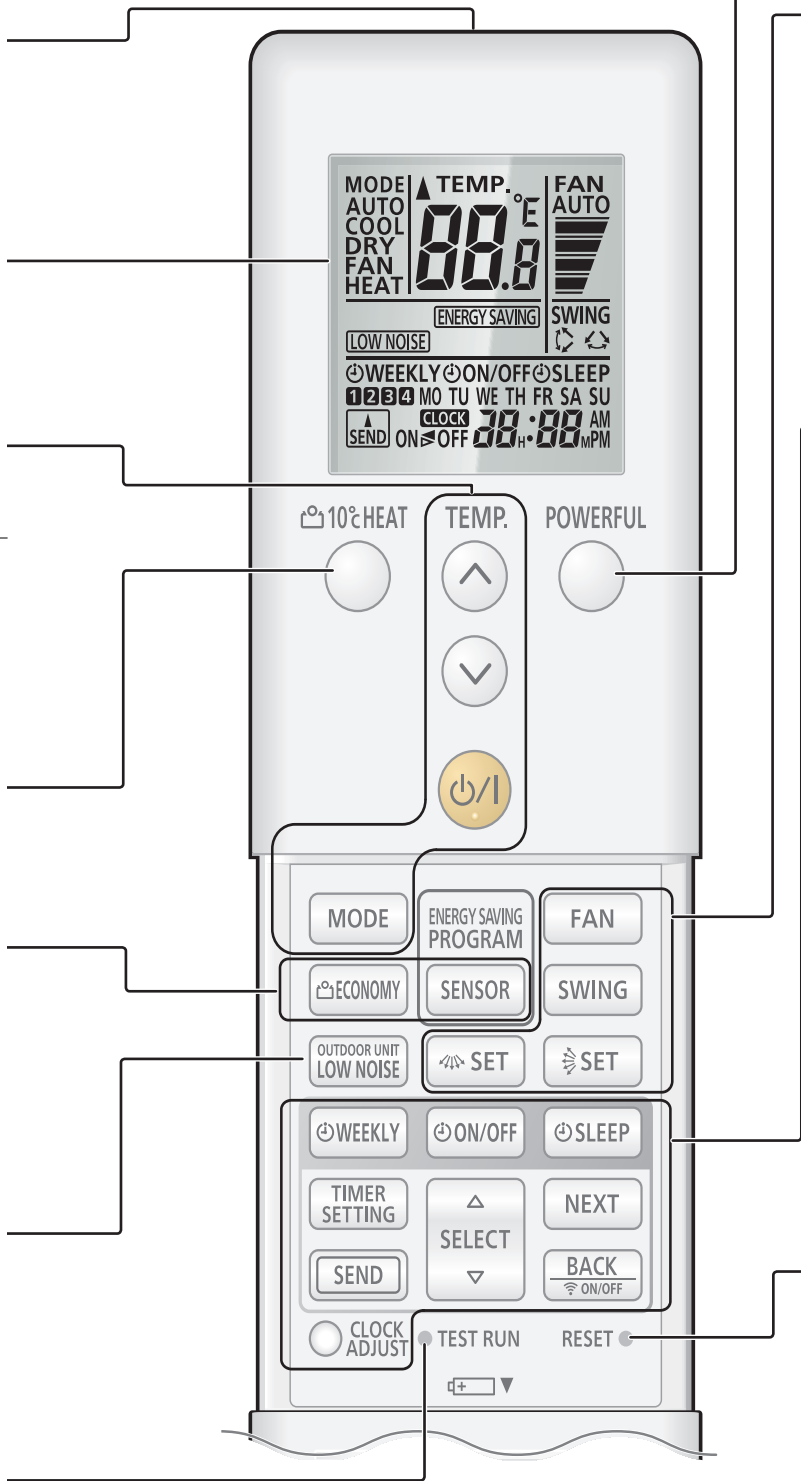

4. BASIC OPERATIONS

3 steps to start operation

1. Pres **(ON)** to start or stop the operation.
2. Pres **(MODE)** to select the operation mode.
The operation mode changes as follows

3. Pres **(TEMP)** to set the desired temperature.
The temperature changes by 0.5 °C increments

Temperature setting range	
Auto/Cooling/Dry	18.0 - 30.0 °C
Heating	16.0 - 30.0 °C

NOTES:

- In the Cooling or Dry mode, set the temperature lower than the current room temperature.
- In the Heating mode,
 - set the temperature higher than the current room temperature.
 - at the beginning of the operation, the indoor unit fan rotates at very low speed for 3-5 minutes
 - the Automatic defrosting operation overrides the Heating operation when necessary
- In the Fan mode, temperature control is not available.

Temperature unit switching

1. Pres **(ON)** until only the block is displayed.
2. Pres down **(TEMP)** for more than 5 seconds
The current temperature unit will be displayed. (Factory setting: °C)
3. Pres **(TEMP)** to switch the temperature unit. (°C ↔ °F)
4. Pres **(ON)** to finish the setting.
If you do not press the button for 30 seconds the displayed temperature unit will be set.

5. AIRFLOW SETTINGS

5.1. Fan speed setting

- Pres **(FAN)** to control the fan speed.
The fan speed changes as follows
- 

When **AUTO** is selected, the fan speed depends on the operating condition.

To increase the air cleaning effect, set the fan speed to High.

5.2. Airflow direction setting

For details of the airflow ranges, refer to "Airflow direction range".

Vertical airflow direction setting

- Pres **(SET)** to adjust the vertical airflow direction.

Horizontal airflow direction setting

- Pres **(SET)** to adjust the horizontal airflow direction.

Swing operation setting

- Pres **(SWING)** to select the Swing operation.
The Swing operation changes as follows

NOTES: The Swing operation may stop temporarily when the indoor unit fan is rotating at very low speed or is stopped.

Airflow direction range

Vertical airflow direction

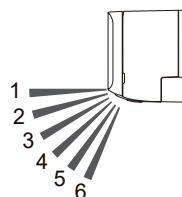

Change by (SET)	1 ↔ 2 ↔ 3 ↔ 4 ↔ 5 ↔ 6
Swing operation by (SWING)	
Cooling, Dry	1 ↔ 4
Heating	3 ↔ 6
Fan *	1 ↔ 4 or 3 ↔ 6

* The Swing operation range depends on the airflow direction set before the Swing operation.

NOTES:

- Do not adjust the airflow direction louvers by hand.
- In the Auto or Heating mode, the airflow direction stay position 1 for a while from the start of the operation.
- In the Cooling or Dry mode, position 1-3 is recommended to prevent condensation drips damaging your property. If position 4-6 keeps for 30 minutes or more in these modes, the airflow direction changes to position 3 automatically.

Horizontal airflow direction

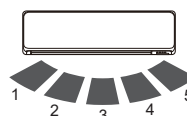

Change by (SET)	1 ↔ 2 ↔ 3 ↔ 4 ↔ 5
Swing operation by (SWING)	1 ↔ 5

NOTES: In the Auto mode operation, you cannot change the airflow direction for a while from the start of the operation.

6. TIMER OPERATIONS

NOTES: When [] indicator on the indoor unit blinks at the block and timer again. This blinking shows that the internal block goes wrong due to an interruption of the power supply (Refer to page 11.)

Timer setting procedure

Before setting the timer, please adjust the block (Refer to "remote controller preparation").

1. Pres **(TIMER SETTING)**.
WEEKLY on the remote controller display will blink
2. Pres **(SELECT)** to choose timer operation.
The timer operation will change as follows

(WEEKLY)	Weekly timer	Enables you to set operation schedules up to 4 setting for each day of the week
(ON/OFF [ON])	On timer	Starts the operation at your desired time.
(ON/OFF [OFF])	Off timer	Stops the operation at your desired time.
(ON/OFF [ON/OFF])	Program timer	Operates as the combination of the On timer and Off timer.
(SLEEP)	Sleep timer	Supports your comfortable sleep by moderating the air conditioner operation gradually

3. Pres **(NEXT)**.
4. Set each timer operation.
For details refer to the following instructions of each timer setting.
5. Pres **(SEND)** to complete the timer setting.
Be close to the indoor unit.

- To cancel the timer setting during the procedure, pres **(TIMER SETTING)** again.

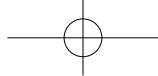

6.1. Weekly timer

Setting details

- Select Weekly timer in step 2 of "Timer setting procedure".
- Press **SELECT** ($\Delta \nabla$) to select the program number and the day of the week
Selected program number (1~4) and the day of the week will blink

MO	Monday
TU	Tuesday
WE	Wednesday
TH	Thursday
FR	Friday
SA	Saturday
SU	Sunday

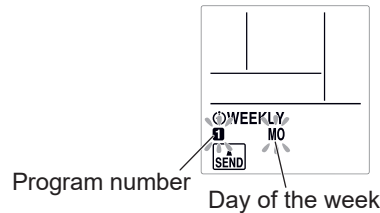

- Press **NEXT**.
- Press **SELECT** ($\Delta \nabla$) to choose the timer operation.

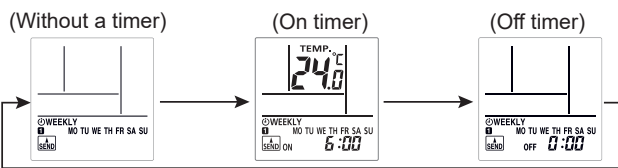

- Press **NEXT**.
* When you choose "Without a timer" in step 4, the setting display will return to step 1.
- Press **SELECT** ($\Delta \nabla$) to set on time or off time.
- Press **NEXT**.
* When you choose "Off timer" in step 4, the setting display will return to step 1.
- Press **SELECT** ($\Delta \nabla$) to set the temperature.

Temperature setting range

Auto, Cooling,	18.0-30.0 °C
or Dry mode:	*Even if you set to 10, 16.0-17.5 °C, the air conditioner will run at 18.0 °C.
Heating mode:	10 or 16.0-30.0 °C

- Press **NEXT**.
The setting display will return to step 1.
- Press **SEND** to complete the setting.
Be back to the indoor unit.

NOTES: [\odot] indicator on the indoor unit will not turn on even if the setting is complete.

- If you want to return the previous step, press **BACK** (\odot ON/OFF).
- To check the schedule, use **SELECT** ($\Delta \nabla$) to browse the Weekly timer settings in step 1.
To finish checking, press **TIMER SETTING**.
- To deactivate the Weekly timer, press **WEEKLY** while \odot WEEKLY is shown on the remote controller display.
The indicator will disappear.

NOTES:

- The operation modes will be the same as the mode at the last time operation was stopped, so Cooling \rightarrow Heating \rightarrow Cooling \rightarrow Heating type of operations cannot be set automatically.
- If you set the On timer and Off timer on the same time, the On timer will work.
- If two On timers are set on the same time, the air conditioner will run in the order of the program number.
- You cannot set the Weekly timer and the other timers simultaneously. If you use the On/Off timer, the Program timer, or the Sleep timer while the Weekly timer is activated, the Weekly timer will be deactivated.
In addition, deactivate the Weekly timer after the other timer finishes.
- If the wired remote controller (optional) is connected, this function is restricted.

Examples of Weekly timer

Example 1

	7:00	9:00	11:00	17:00	23:00
Monday to Friday	Program 1 On 26 °C Wake up	Program 2 Off Leave for work		Program 3 On 28 °C Come back home	Program 4 Off Go to sleep
Saturday	(No timer setting)				
Sunday	(On)	Program 1 Off (On)	Program 2 Off (On)	Program 3 Off (On)	Program 4 Off (On)

Example 2: You can specify temperature settings using the On timer in the Weekly timer.

	7:00	9:00	17:00	23:00
Program 1	On 28 °C	Program 2 On 26 °C	Program 3 On 27 °C	Program 4 On 28 °C

6.2. On timer or Off timer

- Select On timer or Off timer in step 2 of "Timer setting procedure".
 - Press **SELECT** ($\Delta \nabla$) to set on time or off time.
Pressing the button: The time will change by +5/-5 minutes
Pressing down the button: The time will change by +10/-10 minutes
- To deactivate the On/Off timer, press **ON/OFF** while \odot ON/OFF is shown on the remote controller display.
The indicator will disappear.

6.3. Program timer

- Set On timer and Off timer. (Refer to "6.2. On timer or Off timer").
- Select Program timer in step 2 of "Timer setting procedure".
The timer whose setting time is closer to the current time works first.
The order of the timer operation is displayed as follows

Timer	Indicator on the remote controller display
On \rightarrow Off timer	ON \triangleright OFF
Off \rightarrow On timer	ON \triangleleft OFF

NOTES: You can set the Program timer only within a span of 24 hours

6.4. Sleep timer

- Select Sleep timer in step 2 of "Timer setting procedure".
- Press **SELECT** ($\Delta \nabla$) to set the time until the operation stops
Each time you press the button, the time changes as follows



- To deactivate the Sleep timer, press **SLEEP** while \odot SLEEP is shown on the remote controller display.
The indicator will disappear.

During the Sleep timer operation, the setting temperature changes as the following figure.

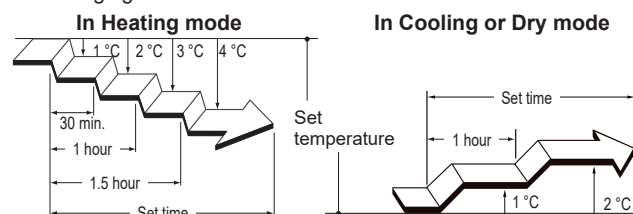

After the set time has elapsed, the air conditioner operation turns off.

7. ENERGY SAVING OPERATIONS

7.1. Economy operation

It allows more electricity than other operation modes by changing the set temperature to a moderate setting.

Press **ECONOMY** to activate/deactivate the Economy operation.

[] indicator on the indoor unit will turn on.

Operation mode	Room temperature
Cooling/Dry	Few degrees higher than the set temperature
Heating	Few degrees lower than the set temperature

NOTES:

- In the Cooling, Heating, or Dry mode, the maximum output of this operation is approximately 70% of usual operation.
- This operation cannot be performed during the temperature monitoring by the Auto mode.

7.2. Human sensor for energy saving

WARNING

- Do not use this function when there are only infants, children, elderly or sick persons in the room.

CAUTION

- Do not use this function in outdoor rooms or other places where there is no one in the room.
- Do not place large objects near the human sensor. Also keep heating units outside the sensor's detection area.

When no one is in the room, the air conditioner operates moderately to prevent waste of electricity (This function is activated at the time of purchase.)

To change the setting, press **SENSOR**.

While the Energy Saving program is activated, **ENERGY SAVING** on the remote controller display will turn on.

NOTES:

- The following operations will override the Energy Saving program.
 - Sleep timer operation
 - 10 °C Heat operation
- The Energy Saving program may not work when the room temperature is very different from the set temperature, such as when immediately after starting the operation.

Details on Energy Saving program

Human sensor on the indoor unit detects movement of people.

If there is no one in the room for approximately 20 minutes the temperature will be adjusted moderately.

When someone comes back into the room, the air conditioner returns to the original settings.

Operation mode	Room temperature (When there is no one there)
Cooling/Dry	Higher than the set temperature (Max. +2°C)
Heating	Lower than the set temperature (Max. -4°C)
Auto	Depending on the operating mode (Cooling/ Heating/ Dry).

Detection range of Human sensor

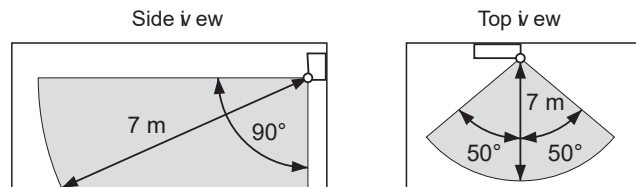

NOTES: Since Human sensor detects infrared light given out by people, the detection may be incorrect in the following situations.

Situations in which the sensor may detect no one in the room, even when there is someone there:

- When the room temperature is high and the difference with people's body temperature is small. (Such as when the temperature is 30°C or higher in summer.)
- When someone in the room do not move for a long time.
- When someone is hidden behind a sofa, other furniture, glass or in similar situations.
- When someone is wearing extremely thick clothing and turn their back on the sensor.

Situations in which the sensor may detect people in the room, even when there is no one there:

- When there is a dog or a cat moving around in the room.
- When wind is moving curtains or plants.
- When heating units, humidifiers, or electric appliances such as oscillating electric fans are operating.

7.3. Fan control for energy saving

In the Cooling operation, when the room temperature reaches the set temperature, the indoor unit fan rotates intermittently to save power. (This function is deactivated at the time of purchase.)

To change the setting, use the following steps.

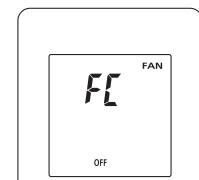

- Press **ON/OFF** until only the block is displayed on the remote controller display.
- Press down **FAN** for more than 5 seconds. The current Fan Control status (FAN) is displayed.
- Press **TEMP.** () to switch between activated (ON) or deactivated (OFF).
- Press **ON/OFF** to end the setting to the indoor unit. The display will return to the original screen.

NOTES: If you do not press any buttons for 30 seconds after FAN is displayed, FAN will turn off. In this case, repeat the setting from step 2.

7.4. Demand Response

This product is designed to be compatible with Air Conditioning Demand Response program.

To utilize the function, you need a separate arrangement with your electricity supplier. Please check availability in the place of use.

When your electricity supplier activates one of the following 3 Demand Response (DR) modes the air conditioner switches over to the appropriate operation.

During the DR mode, [] indicator on the indoor unit will blink.

Blinking pattern and the indicators are as follows.

Operation mode	Indicator lamp blinking pattern
Auto/Cooling/Heating/Dry Fan	On → Blink (2 times)
10°C Heat operation	Off → Blinks (2 times)

When the DR mode finishes, the air conditioner returns to the operation set before entering the DR mode.

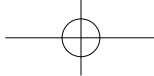

■ Details on Demand Response mode

DR mode	Description of operation in this mode
DR mode 1	Compressor off.
DR mode 2	electrical energy consumption in 30 minutes 50 % or less (compared with rated energy consumption)
DR mode 3	electrical energy consumption in 30 minutes 75 % or less (compared with rated energy consumption)

NOTES:

- During the DR mode, the cooling or heating performance may be reduced.
- During the DR mode, only the following operations are allowed.
 - Turning off the operation by
 - Off timer operation
- The Powerful operation is performed within the operable range of the DR mode.
- During the DR mode, the Filter sign will not display.
- Timer setting error indicator will be prioritized over the DR mode indicator.

If you have operational issues:

- Contact your electricity supplier to check whether they are activating the DR mode.
- Is the air conditioner under the Demand controlling?

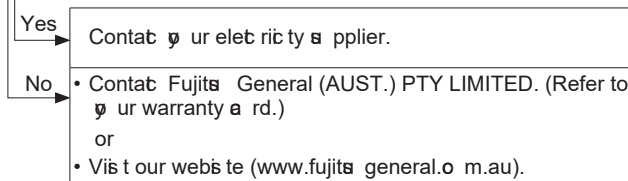

8. OTHER OPERATIONS

8.1. Powerful operation

In the Powerful operation, the air conditioner will operate at maximum power and strong airflow to cool down or warm up the room quickly.

- Press to activate/deactivate the Powerful operation.
 - When activated, the indoor unit will emit 2 short beeps.
 - When deactivated, the indoor unit will emit 1 short beep.

The Powerful operation will be turned off automatically in the following situations

- The Powerful operation runs for a certain amount of time and the room temperature reaches the set temperature in the Cooling, Dry or Heating mode.
- 20 minutes after the Powerful operation has started.

NOTES:

- The airflow direction and the fan speed are controlled automatically.
- The Powerful operation cannot be performed simultaneously with Economy operation.
- The Powerful operation overrides the following operations. If the following operations are set, they will start after the Powerful operation finishes.
 - Outdoor Unit Low Noise operation
 - Energy Saving program
- If the wired remote controller (optional) is connected, this function is restricted.

8.2. Outdoor Unit Low Noise operation

The Outdoor Unit Low Noise operation lowers noise from the outdoor unit. During this operation, the rotation number of the compressor decreases and the outdoor unit fan rotates slowly.

- Press to activate/deactivate the Outdoor Unit Low Noise operation.

While the Outdoor Unit Low Noise operation is activated, **LOW NOISE** on the remote controller is displayed.
The setting is preserved even if the air conditioner is turned off.

NOTES:

- This operation cannot be performed simultaneously with the Fan mode, Dry mode, and Powerful operation.
- If the wired remote controller (optional) is connected, this function is restricted.

8.3. 10 °C Heat operation

10 °C Heat operation maintains the room temperature at 10 °C so as to prevent the room temperature to drop too low.

- Press to activate the 10 °C Heat operation.
 - The indoor unit will emit 1 short beep and indicator on the indoor unit will turn on.

- Press to turn off the air conditioner.
 - indicator will turn off.

NOTES:

- During the 10 °C Heat operation, only and are allowed.
- When the room temperature is warm enough, this operation will not perform.
- If the wired remote controller (optional) is connected, this function is restricted.

9. SETTINGS ON INSTALLATION

9.1. Remote controller custom code setting

By setting a submode of indoor unit and remote controller, you can specify the air conditioner which the remote controller controls.

When two or more air conditioners are in the room and you wish to operate them separately set the submode (4 selections possible).

NOTES: If custom codes is different between the indoor unit and the remote controller, the indoor unit cannot receive a signal from the remote controller.

How to set the remote controller custom code

- Press until only the block is displayed on the remote controller display.
- Press down **MODE** for more than 5 seconds.
 - The current submode will be displayed (initially set to A).
- Press **TEMP** () to change the custom code between A↔B↔C↔D.
 - * Match the submode on the display to the air conditioner submode.
- Press **MODE** again.
 - The submode will be set.
 - The display will return to the block display.

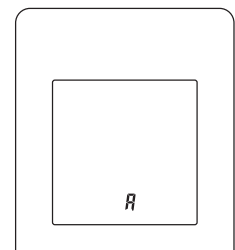

- To change the air conditioner submode, contact an authorized service personnel (initially set to A).
- If you do not press any buttons for 30 seconds after the submode is displayed, the display returns to the block display. In this case, repeat the setting from step 2.
- Depending on the remote controller, the submode may return to A when replacing the batteries. In this case, reset the submode as necessary. If you do not know the air conditioner submode code, try each code until you find the code which operates the air conditioner.

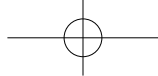

10. CLEANING AND CARE

CAUTION

- ! Before cleaning this product, be sure to turn it off and disconnect all the power supply.
 - Before starting operation, make sure that the intake grille has been shut completely. Incomplete closing of the intake grille might have an effect on the proper working or performance of the air conditioner.
 - Be careful not to drop the intake grille.
 - If the filter cleaning involves high-place work, please consult the authorized service personnel.
- ⊘ Do not touch the aluminum fins of heat exchanger built-in the indoor unit to avoid personal injury when you maintain the unit.
 - Do not expose the indoor unit to liquid insecticides or hair spray.
 - Do not stand on slippery uneven or unstable surfaces when you maintain the unit.

Air cleaning filters
(Apple catechin filter, Ion deodorization filter)

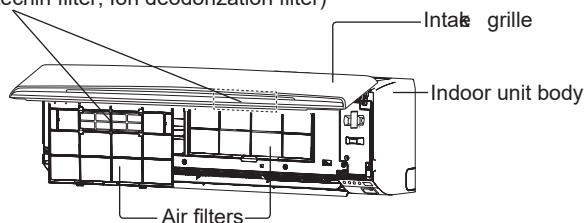

The frequency of the cleaning is as shown in the following table.

What to do	Frequency
Cleaning indoor unit body	When you notice
Cleaning intake grille	
Cleaning air filter	Every 2 weeks
Cleaning Ion deodorization filter	Every 3 months
Replacing Apple-catechin filter (Model name: UTR-FA13-1)	Every 3 years
Replacing Ion deodorization filter (Model name: UTR-FA13-2)	

* The air cleaning filters are sold separately. When you replace them, please consult the store of purchase.

Cleaning indoor unit body

NOTES:

- Do not use water hotter than 40 °C.
 - Do not use soiling beans, volatile solvents such as benzene or thinner.
1. Wipe the indoor unit body gently with a soft cloth moisten with warm water.
 2. Wipe the indoor unit body gently with a dry and soft cloth.

Cleaning intake grille

Removing intake grille

1. Open the intake grille.
2. While pressing the left and right mounting brackets outward, gently pull the intake grille.

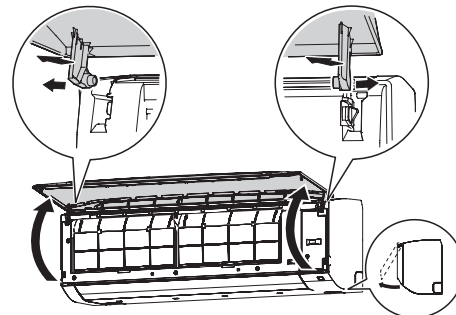

Cleaning intake grille

1. Wash the intake grille gently with water or wipe it gently with a soft cloth moisten with warm water.
2. Wipe the intake grille with a dry and soft cloth.

Installing intake grille

1. While holding the intake grille horizontal, set the left and right mounting brackets into the pillow blocks at the top of the front panel. Insert the bracket until it snaps to latch each bracket properly.
2. Close the intake grille.

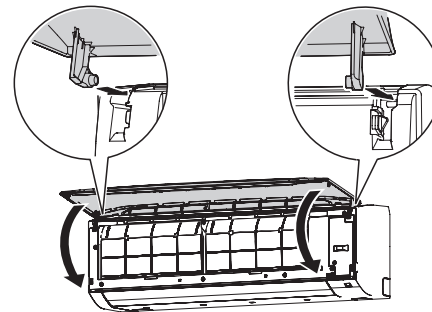

3. Press 4 places on the intake grille to close it completely.

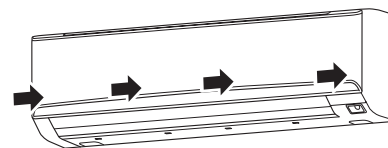

Cleaning air filter

1. Open the intake grille.

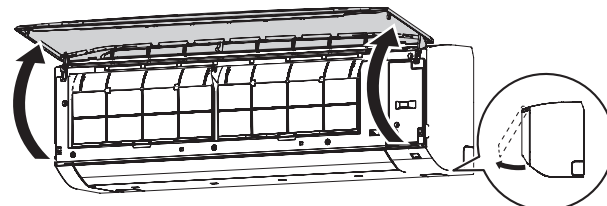



2. Remove the air filters.

Lift up the air filters' handle, disconnect the two lower tabs, and pull out.

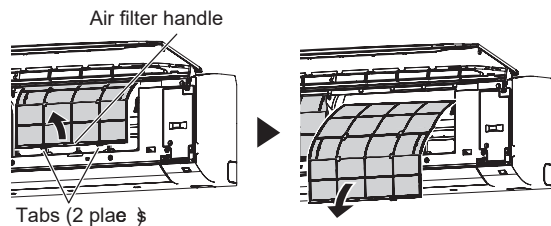

3. Remove the dust in either of the following ways

- Cleaning with a vacuum cleaner.
- Washing with mild detergent and warm water. After washing, dry the air filters thoroughly in shade.

4. Replace the air filters.

Align the sides of the air filter with the panel, and push in fully. Make sure the two lower tabs are returned to their holes in the indoor unit properly.

5. Close the intake grille.

Press 4 places on the intake grille to close it completely.

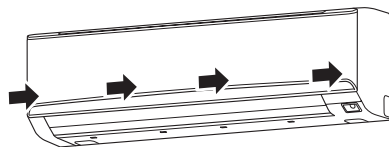

NOTES: If dirt accumulates on the air filter, airflow will be reduced, operating efficiency will lower, and the noise will increase.

Cleaning Ion deodorization filter and Replacing Apple-catechin filter

1. Remove the air filters. Refer to steps 1 ~ 2 of "Cleaning air filter".

2. Remove the air cleaning filters from the air cleaning filter holder.

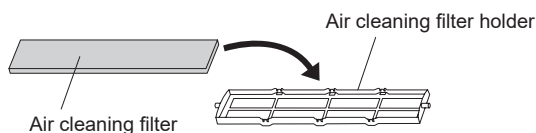

3. Flush the Ion deodorization filter (light blue) with high-pressure hot water until the surface of the filters are covered with water.

4. Wash the Ion deodorization filter with diluent neutral detergent.

Do not ream or rub, otherwise the deodorizing effect may decrease.

5. Rinse the Ion deodorization filter with water flow.

6. Dry the Ion deodorization filter in shade.

7. Remove the Apple-catechin filter (light green) from the air cleaning filter holder.

8. Set the new or washed air cleaning filters into the air cleaning filter holders.

NOTES: Use the Apple-catechin filter as soon as possible after opening the package. The air cleaning effect decreases when the filters are left in the opened package.

9. Install the air cleaning filter holders to the air filters.

Engage the 2 hooks at the rear of the air cleaning filter holder with the tabs at both ends of the air holder.

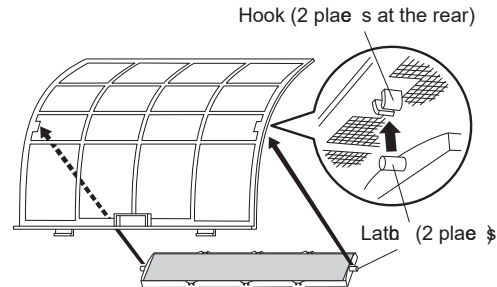

NOTES: Take care that the air cleaning filter does not project beyond the holder.

10. Engage the six fixing locations at the top and bottom of the air cleaning filter holder with the hooks of the air filter.

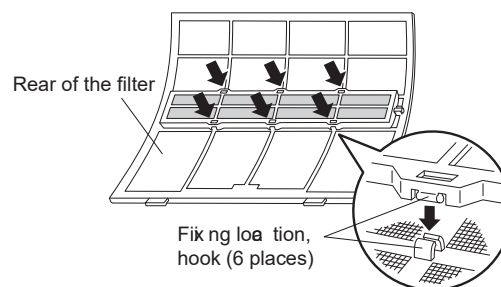

11. Replace the air filters and close the intake grille. Refer to steps 4 ~ 5 of "Cleaning air filter".

Replacing Ion deodorization filter

1. Remove the air filters. Refer to steps 1 ~ 2 of "Cleaning air filter".

2. Remove the Ion deodorization filter (light blue) from the air cleaning filter holder.

3. Install the new Ion deodorizing filter.

After extended non-use of the unit

If you have shut down the indoor unit for 1 month or more, perform the Fan mode operation for half a day to dry the internal parts thoroughly before the normal operation.

Additional inspection

After long period of use, accumulated dust inside the indoor unit may reduce the performance even if you have maintained the unit properly.

In such a case, a product inspection is recommended.

For more information, consult authorized service personnel.

Filter indicator reset (Special setting)

This function can be used if set correctly during installation. Please consult authorized service personnel in order to use this function.

Clean the air filter when the indicator lamp shows the following:

Indicator lamp	Blinking pattern
	Blinks 3 times at intervals of 21 seconds

After cleaning, reset the filter indicator by pushing on the indoor unit for 2 seconds or less.

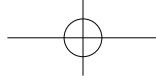

11. GENERAL INFORMATION

■ Heating performance

This air conditioner operates on the heat-pump principle, absorbing heat from air outdoors and transferring that heat to the indoor unit. As a result, the operating performance is reduced as outdoor air temperature drops.

If you feel that the heating performance is insufficient, we recommend you to use this air conditioner in conjunction with other kinds of heating appliances.

■ Automatic defrosting operation

When outdoor temperature is very low with high humidity, frost may form on the outdoor unit during the heating operation, and it could reduce the operating performance of the product.

For frost protection, a micro-computer-controlled automatic defrost function is equipped in this air conditioner.

If frost forms, the air conditioner will temporarily stop, and defrost (it will operate briefly (maximum of 15 minutes).

[] indicator on the indoor unit blinks during this operation.

If frost forms on the outdoor unit after the Heating operation, the outdoor unit will stop automatically after it operates for a few minutes. Then the Automatic defrosting operation starts.

■ Auto-restart function

In event of power interruption such as a blackout, the air conditioner stops once. But it restarts automatically and performs previous operation when the power supply is resumed.

If any power interruption occurs after the timer is set, counting down of the timer will be reset.

After the power supply is resumed, [] indicator on the indoor unit blinks to notify you that there has been a timer fault. In such a case, reset the clock and timer settings.

■ Malfunctions caused by other electrical devices

Use of other electrical appliances such as an electric heater or nearby use of a wireless radio transmitter may cause the malfunction of the air conditioner.

If you encounter such a malfunction, turn off the circuit breaker once. Then turn it on again, and resume operation by using the remote controller.

■ Indoor unit temperature and humidity range

Permissible ranges of temperature and humidity are as follows.

Indoor temperature	Cooling/Dry	[°C]	18 to 32
	Heating	[°C]	16 to 30
Indoor humidity		[%]	80 or less ^{*1)}

*1) If the air conditioner is used continuously for many hours, water may condense on the surface and drip.

- If the unit is operated under the conditions except the permissible temperature range, the air conditioner operation may stop because of the automatic protection circuit working.
- Depending on the operating conditions, the heat exchanger may freeze, causing water leakage or other malfunction (in the Cooling or Dry mode).

■ Other information

- Do not use the air conditioner for any purpose other than room cooling/dry room heating or fan.
- For the permissible ranges of temperature and humidity for the outdoor unit, refer to the outdoor unit installation manual.

12. OPTIONAL PARTS

12.1. Wired remote controller

The optional wired remote controller can be used.

You can use wired and wireless remote controller together.

However, some functions of the wireless remote controller are restricted. If you set the restricted functions, beeping sound will be heard, [], [], [], and [] indicator on the indoor unit will blink.

<Restricted functions for wireless remote controller>

When using together with wired remote controller (2-wired type)

- Weekly timer operation
- Powerful operation
- Outdoor Unit Low Noise operation
- 10 °C Heat operation

Group control

One remote controller can control up to 16 air conditioners. All of the air conditioners will be operated with the same settings.

NOTES:

- Be aware to deactivate the Energy saving program (human sensor) of the wireless remote controller when you use the group control. Otherwise you cannot operate the air conditioner by the wireless remote controller.

13. TROUBLESHOOTING

WARNING

 In the following events immediately stop operation of the air conditioner, and disconnect all the power supply by turning off the electrical breaker or disconnecting the power plug. Then consult your dealer or authorized service personnel.

As long as the unit is connected to the power supply it is not insulated from the power supply even if the unit is turned off.

- Unit smells of something burning or emits smoke
- Water leaks from the unit

Does not operate at all.

- Has there been a power outage?
In this case, the unit restarts automatically after the power supply is resumed. (Refer to **page 11**.)
- Has the circuit breaker been turned off?
⇒ Turn on the circuit breaker.
- Has a fuse blown out or the circuit breaker been tripped?
⇒ Replace the fuse or reset the circuit breaker.
- Is the timer operating?
⇒ To be electric or deactivate the timer setting, refer to **page 5**.

Poor cooling or heating performance.

- Is the unit operating under the conditions except the permissible temperature range?
In this case, the air conditioner may stop because of the automatic protection circuit working.
- Do you have an arrangement with your electric company for Demand Response?
In this case, the air conditioning performance may become lower or the operation may stop. (Refer to **page 7**.)
- Is the air filter dirty?
⇒ Clean the air filter. (Refer to **page 9**.)
- Is the intake grille or outlet port of indoor unit blocked?
⇒ Remove the obstructions
- Is the room temperature adjusted appropriately?
⇒ To change the temperature setting, refer to **page 5**.
- Is a window or door left opened?
⇒ Close the window or the door.
- Is the fan speed set to Quiet?
⇒ To change the fan speed, refer to **page 5**.
- Has the Outdoor Unit Low Noise operation been set?
⇒ To stop the Outdoor Unit Low Noise operation, refer to **page 8**.
- <In the Cooling mode> Is direct or strong sunlight shining into the room?
⇒ Close the curtains
- <In the Cooling mode> Are there other heating apparatus or computers operating, or too many people in the room?
⇒ Turn the heating apparatus or computers off, or set the temperature lower. (Refer to **page 5**.)

Airflow is weak or stops.

- Is the fan speed set to Quiet?
⇒ To change the fan speed, refer to **page 5**.
- Has the Fan Control for Energy Saving set? In this case, the indoor unit fan may stop temporarily while the Cooling operation.
⇒ To cancel the Fan control for energy saving, refer to **page 7**.
- <In the Heating mode> Have you just started the operation?
In this case, the fan rotates at very low speed temporarily to warm up the internal parts of the unit.
- <In the Heating mode> Is the room temperature higher than the set temperature?
In this case, the outdoor unit stops and the indoor unit fan rotates at very low speed.
- <In the Heating mode> Is [I] indicator blinking?
In this case, the Automatic defrosting operation is working. The indoor unit stops for maximum of 15 minutes. (Refer to **page 11**.)
- <In the Dry mode> The indoor unit operates at low fan speed to adjust the room humidity and may stop from time to time.
- <In the Auto mode> While the monitoring operation, the fan rotates at very low speed.

Noise is heard.

- Is the unit operating, or immediate after stopping operation?
In this case, refrigerant flowing sound may be heard. It may be partially noticeable for 2-3 minutes after starting operation.
- Do you hear a slight squeaking sound during the operation?
This sound is produced by the minute expansion and contraction of the front panel caused by temperature change.
- <In the Heating mode> Do you hear a sizzling sound?
This sound is produced by the Automatic defrosting operation. (Refer to **page 11**.)

Smell coming from the unit.

- The air conditioner may absorb various smells generated from interior textile, furniture, or cigarette smoke. These smells may be emitted during the operation.

Mist or steam is emitted from the unit.

- <In the Cooling or Dry mode> A thin mist may be generated by condensation formed with added cooling process
- <In the Heating mode> Is [I] indicator on the indoor unit blinking?
In this case, steam may rise from the outdoor unit because of the Automatic defrosting operation. (Refer to **page 11**.)

Outdoor unit emits water.

- <In the Heating mode> The outdoor unit may emit water generated by the Automatic defrosting operation. (Refer to **page 11**.)

The unit operates differently from the remote controller setting.

- Do you have an arrangement with your electric company for Demand Response?
In this case, the air conditioning performance may become lower or the operation may stop. (Refer to **page 7**.)
- Are the batteries in the remote controller exhausted?
⇒ Replace the batteries
- Do you use the group control?
In this case, if the Energy saving program (Human sensor) on the wireless remote controller is activated, you cannot operate the air conditioner by the wireless remote controller.
⇒ Deactivate the Energy saving program. (Refer to **page 7**.)

Operation is delayed after restart.

- Has the power supply turned from Off to On suddenly?
In this case, the compressor will not operate for about 3 minutes to prevent a blowout of the fuse.

Immediately stop operation and turn off the electrical breaker in following cases. Then consult authorized service personnel.

- The problem persists even if you perform the basic or diagnosis
- On the indoor unit, [I] and [⊕] blink while [⊞] is blinking fast.

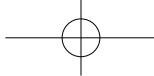

■ State of indicator lamps

Lighting pattern: ○ Off, ● On, ☼ Blinking, — Any state

State	Causes and solutions	See page
☼ (Light) (Clock) (Filter) (Wi-Fi) (Light) (Light) (Light) (Light)	Automatic defrosting operation ⇒ Please wait until finishing the defrosting (maximum of 15 minutes).	11
— (Clock) (Filter) (Wi-Fi) (Light) (Light) (Light) (Light) (3 times)	Filter indicator ⇒ Clean the air filter and reset the filter sign.	10
☼ (Light) (Clock) (Filter) (Wi-Fi) (Light) (Light) (Light) (Light) (Twice)	Demand response operation	7
☼ (Light) (Clock) (Filter) (Wi-Fi) (Light) (Light) (Light) (Light) (Fab)	Error of display ⇒ Contact authorized service personnel.	-
— (Clock) (Filter) (Wi-Fi) (Light) (Light) (Light) (Light)	Timer setting error because of Auto restart ⇒ Reset the clock and timer settings	11
☼ (Light) (Clock) (Filter) (Wi-Fi) (Light) (Light) (Light) (Light)	Test run operation (for authorized personnel only) ⇒ Press (Test) to quit the test run.	3
☼ (Light) (Clock) (Filter) (Wi-Fi) (Light) (Light) (Light) (Light)	Restricted function	11

■ Manual Auto operation and Filter indicator reset

You can operate the air conditioner with  on the indoor unit.

Status	Length of pressing down	Mode or operation
In operation	More than 3 seconds	Stop
Stopping	2 seconds or less	Filter indicator reset
	More than 3 seconds and less than 10 seconds	Auto
	More than 10 seconds (Only for electric heating.*)	Forced cooling

*: To stop the forced cooling, press this button or (Test) on the remote controller.

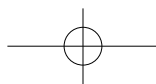
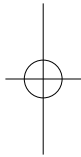
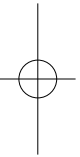

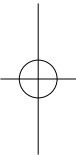
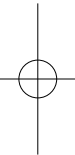
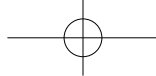

FUJITSU GENERAL LIMITED
3-3-17, Suenaga, Takatsu-ku, Kawasaki 213-8502, Japan

